

---

## chapter 9. ROOF EDGE DETAILS

---

### 9.1 GENERAL

Of all exterior building components, roofs probably have the greatest exposure to environmental and physical abuse. They must be carefully designed and installed to provide the appropriate performance and life expectancy. Because of the wide variation in detailing, this section will not attempt a thorough coverage of roof design, but instead will set forth some basic considerations regarding roof edge detailing that we believe are critical to quality performance.

### 9.2 SHINGLE, SHAKE, AND TILE ROOFING

These systems are similar in basic concept; they are composed of small units that rely on overlaps and underlayment to achieve quality performance. In fact, the primary purposes of the top surface are to provide a water shedding surface and sun and abuse protection for the actual membrane. Accordingly, the underlayment is extremely important in any of these systems. The material must have all the performance requirements of a membrane discussed in Chapter 3 and must be installed in a manner that maintains its integrity. **Table 9-1** sets forth membrane recommendations for these roof systems for various slopes.

In all cases it is important to properly detail and install the edge conditions.

Always try to carry membrane felts over, or up and over, and down to ensure the roof membrane will always drain free and clear of any adjacent system. Also, try to ensure that the membrane does not rely on adhered or embedded sheet metal for waterproofing. The following conceptual details (**Figures 9-1 to 9-6**) show some of the typical conditions commonly encountered.

### 9.3 BUILT-UP ROOFING

Because this is a wood-detailing manual, this section will only attempt to highlight some basic edge conditions that often adversely affect adjacent wood construction. Not only is no attempt made to cover the assembly of built-up roofs, but also the issue of single plys or elastomerics will not be mentioned except to state that some of the basic concepts of good edge conditions are similar to those for built-up roof conditions. Discussion of either of these unbroken membrane-type roofs could easily take a chapter, if not a whole book.

To the authors, a single concept is critical to these roofs and adjacent wood construction: the membrane proper must be kept in an unbroached condition with all edge conditions either above scupper or drain height until water runoff is complete. **Figures 9-7 and 9-8** show some conditions commonly encountered.

**Table 9-1**  
Felt Underlayment Recommendations

	Roof Slope		
	4:12 up	3:12-4:12	Less than 3:12
<b>Wood Shingles</b>			
Solid backing (pressure treated)	NR	2-#15	NR*
Spaced strips	#30	2-#30	NR
<b>Asphalt Shingles</b>			
Solid Sheathing	#15	2-#15	NR
Spaced strips	NR	NR	NR
<b>Wood Shakes</b>			
Solid sheathing (pressure treated)	#30	2-#30	NR
Spaced strips	#30	2-#30	NR
<b>Tile, Cement, or Clay</b>			
Solid sheathing	#30	2-#30	NR
Spaced strips	NR	NR	NR

\* NR - This application not recommended.

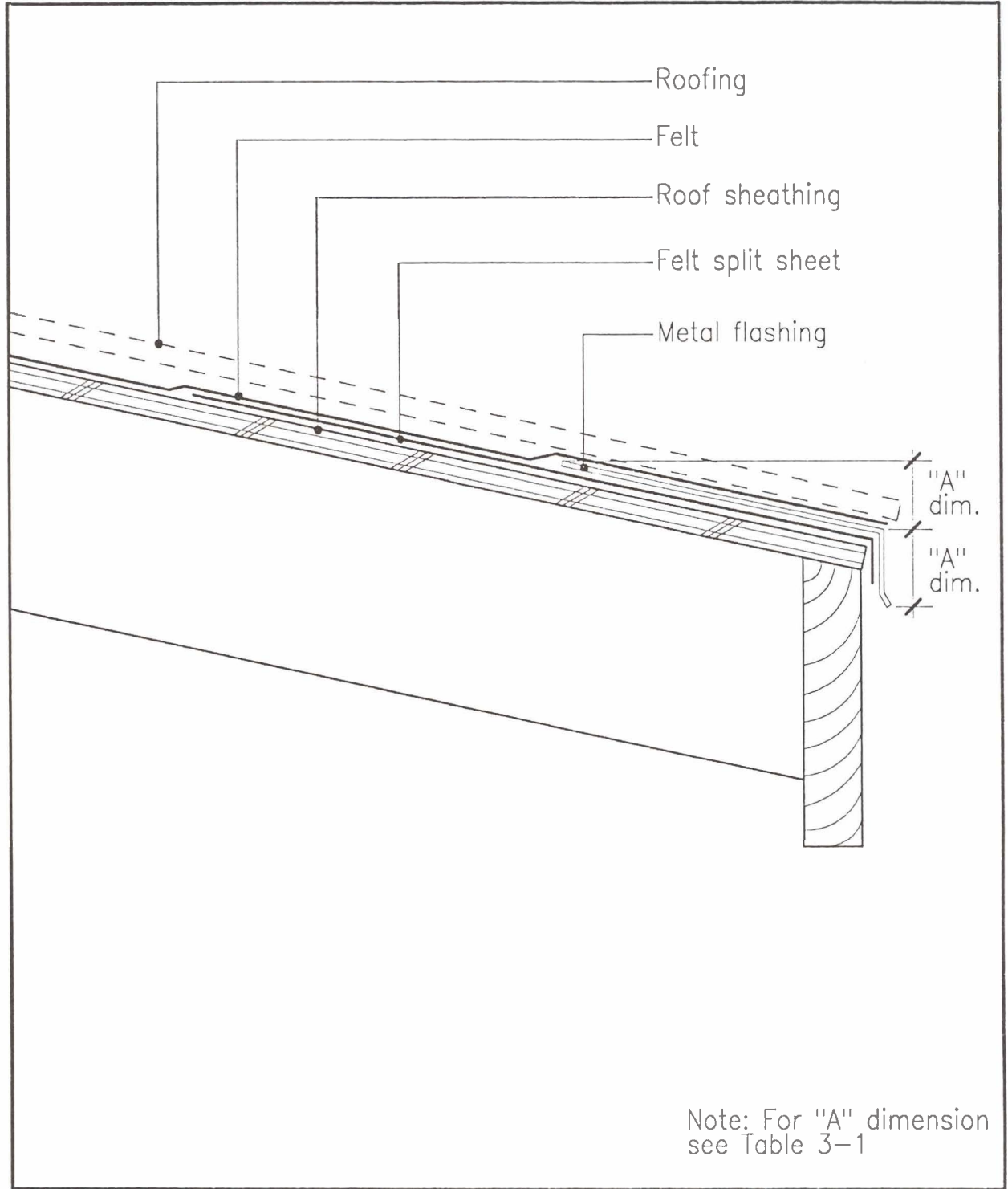

# ROOF DETAIL EAVE OVERHANG

Figure 9-1

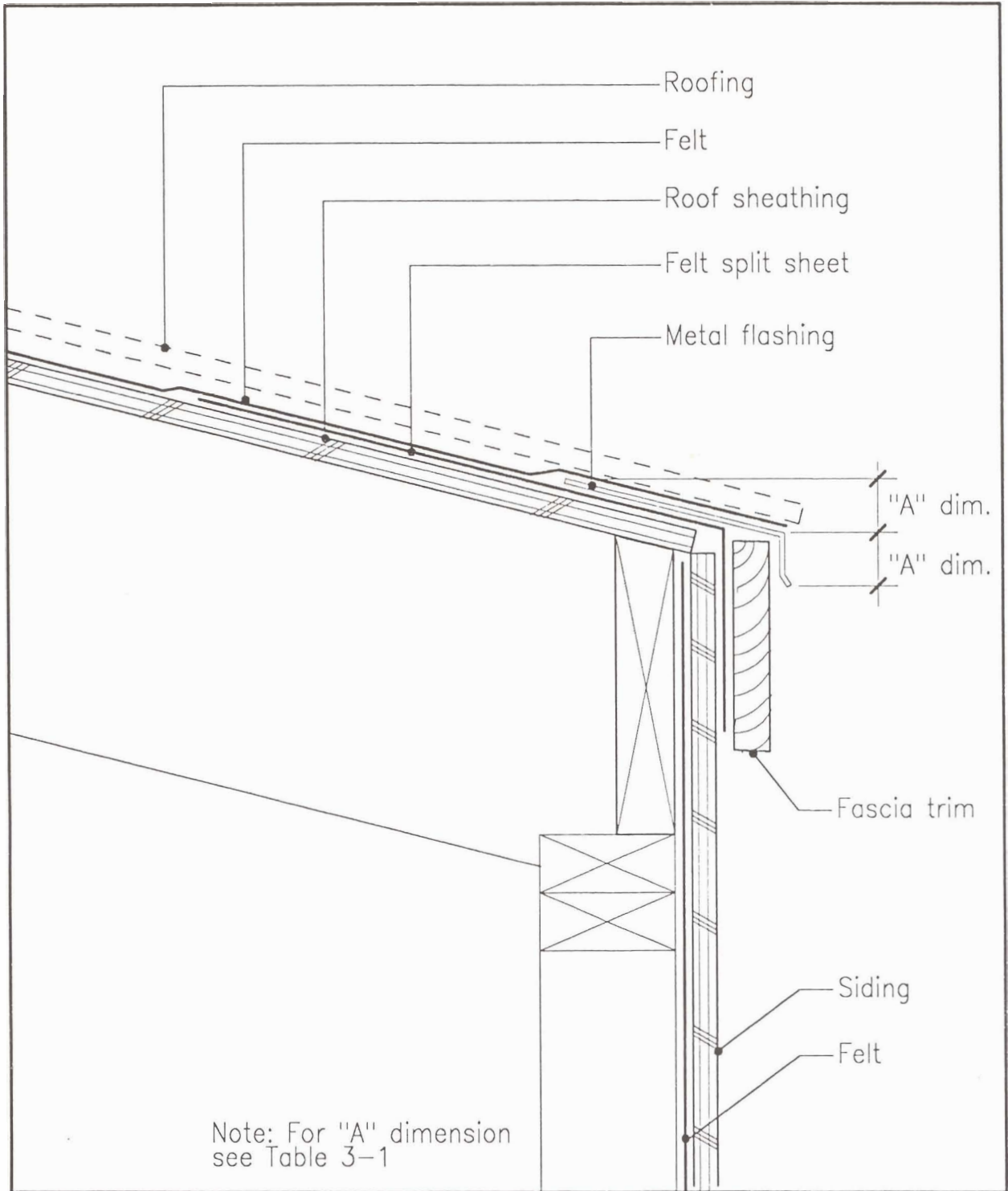

# ROOF DETAIL CLIPPED EAVE

Figure 9-2

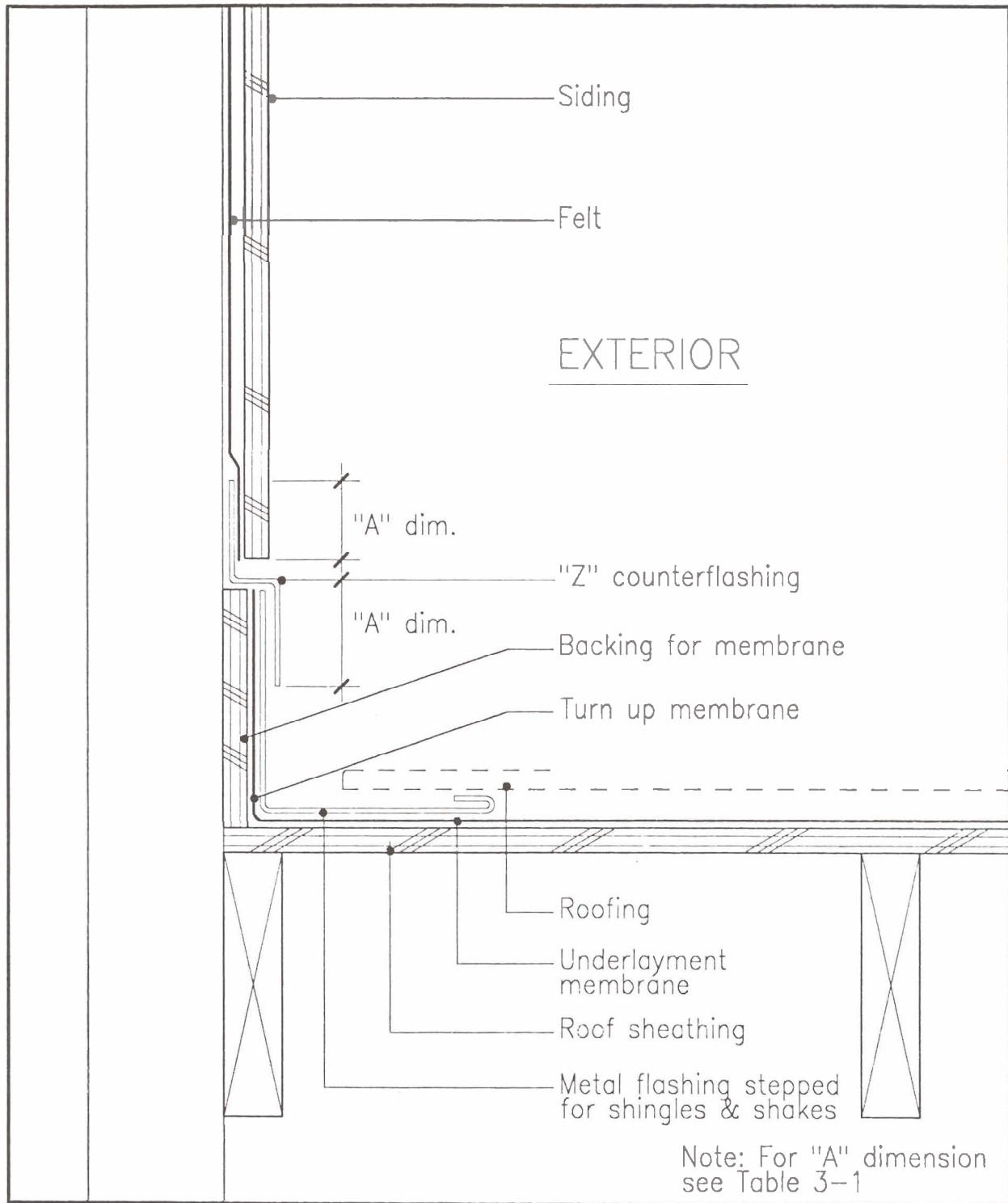

# ROOF DETAIL RAKE AT WALL

Figure 9-3

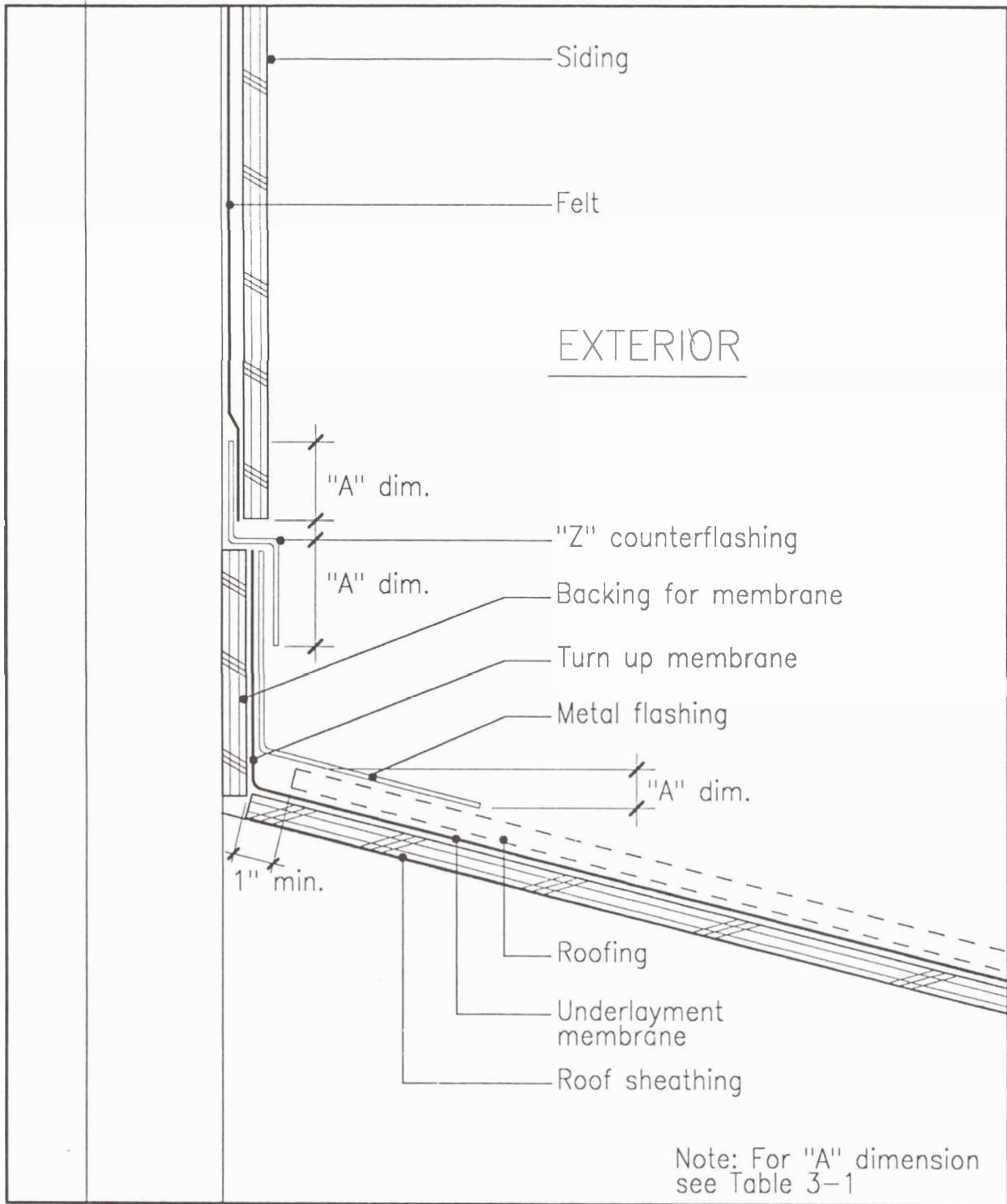

# ROOF DETAIL SLOPED EAVE

Figure 9-4

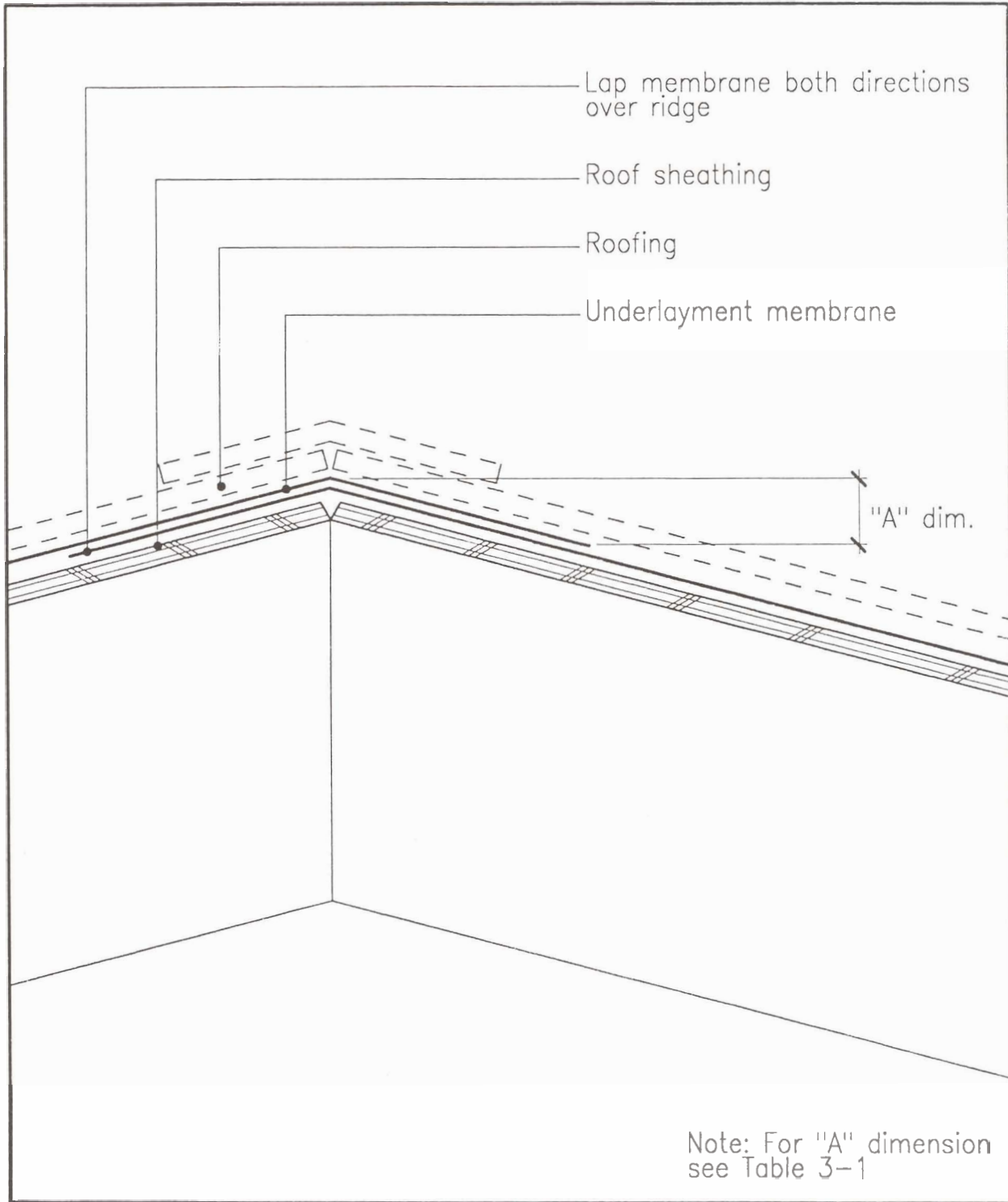

# ROOF DETAIL RIDGE

Figure 9-5

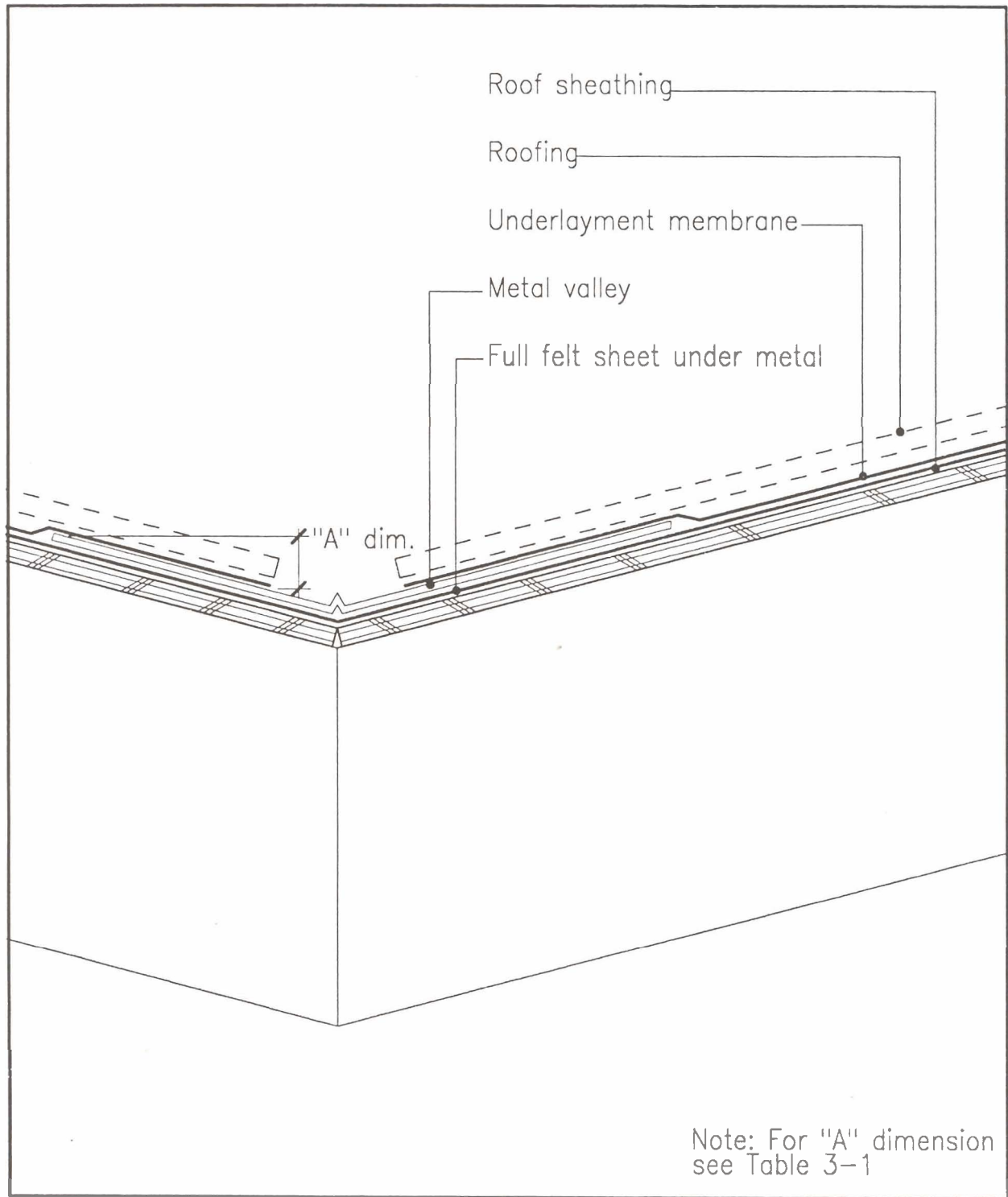

# ROOF DETAIL VALLEY

Figure 9-6



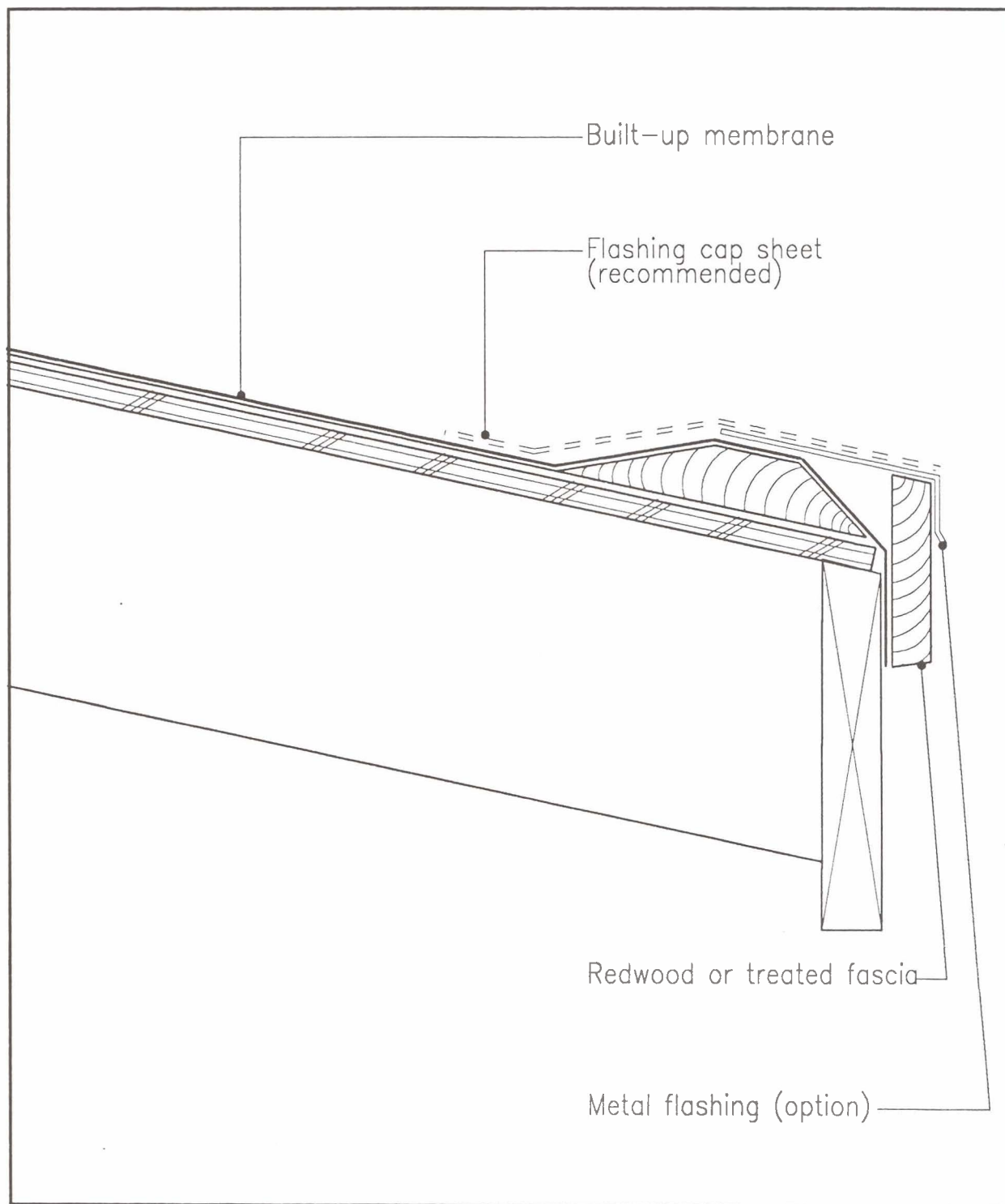

# BUILT-UP ROOF DETAIL EAVE

Figure 9-7

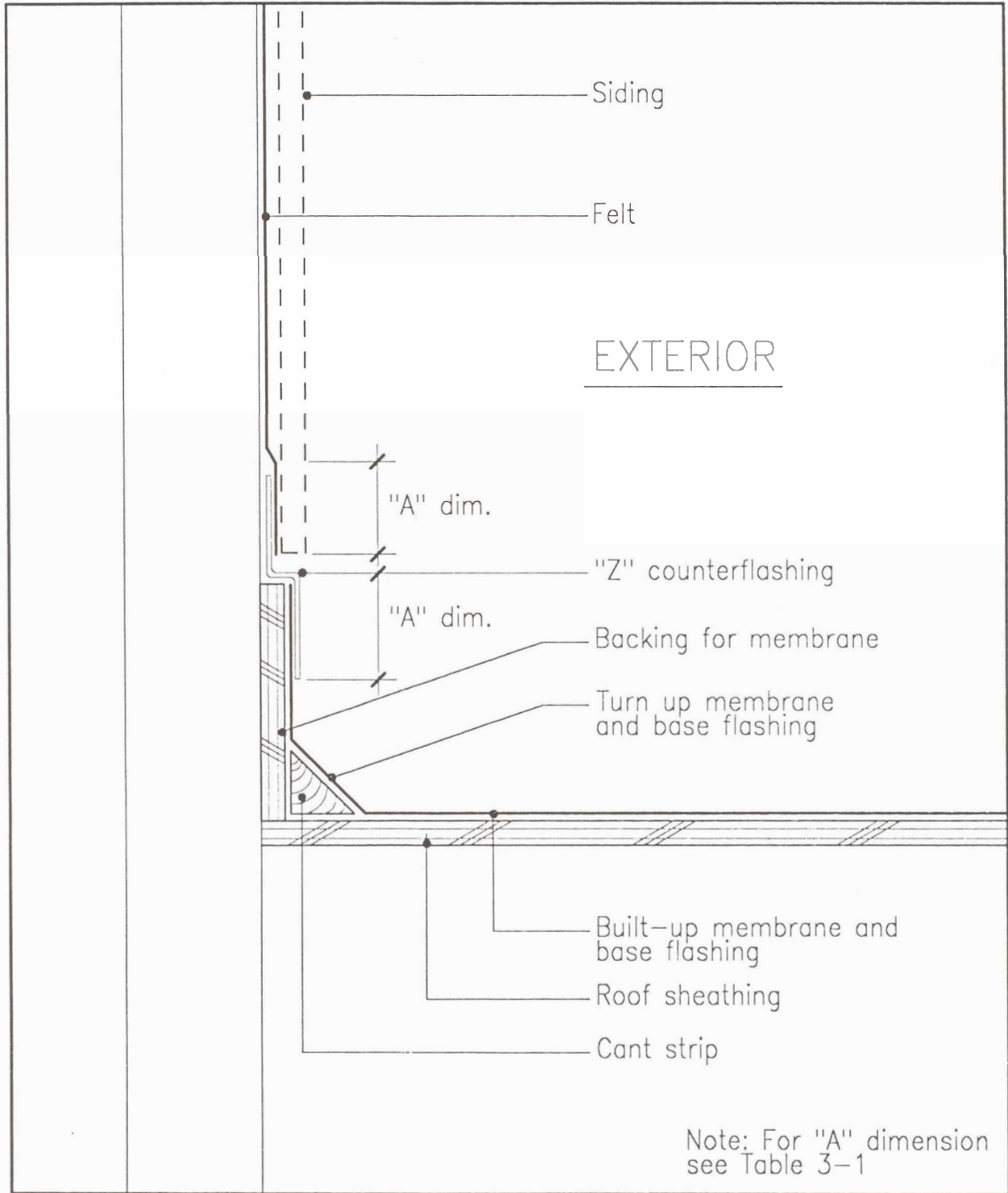

# BUILT-UP ROOF DETAIL RAKE AT WALL

Figure 9-8